



# Replacement technology



---

FOR RESIDENTIAL  
AND COMMERCIAL  
APPLICATIONS

# The Daikin solution to upgrade R-22 and R-407C systems

Due to significant developments in heat pump technology, today's air conditioning systems, running on R-410A refrigerant, offer better performances than R-22 and R-407C systems did in the past. Furthermore, R-22 will be soon unavailable in Europe. Already today, only reclaimed or recycled R-22 can be used for servicing. To upgrade R-22 and R-407C systems as cost effectively as possible, Daikin units can be installed using existing pipe work.

Replacement technology is available for residential and commercial applications in the following ranges:

- > Split
- > Sky Air
- > VRV

## Plan your system replacement now!

The R-22 phase out regulation will impact on all currently operating R-22 systems, although reliable R-22 equipment does not need to be replaced immediately because maintenance can be carried out with recycled or reclaimed R-22 until 1st January 2015. However, not enough R-22 is currently reclaimed or recycled to cover the demand. As a consequence, supply shortages and price increases are expected. If there is no reclaimed or recycled R-22 available, certain repairs (for example: compressor change) will no longer be possible and considerable air conditioning system downtime can occur.

**It is therefore worthwhile to consider a replacement system before 2015, especially for air conditioning systems with a large impact on the daily running of the business.**

## Low cost refurbishment

By reusing the refrigerant piping, the cost of upgrading your system to one using R-410A has been kept to a minimum. In some cases, such as the VRV system, even the indoor unit can be reused.

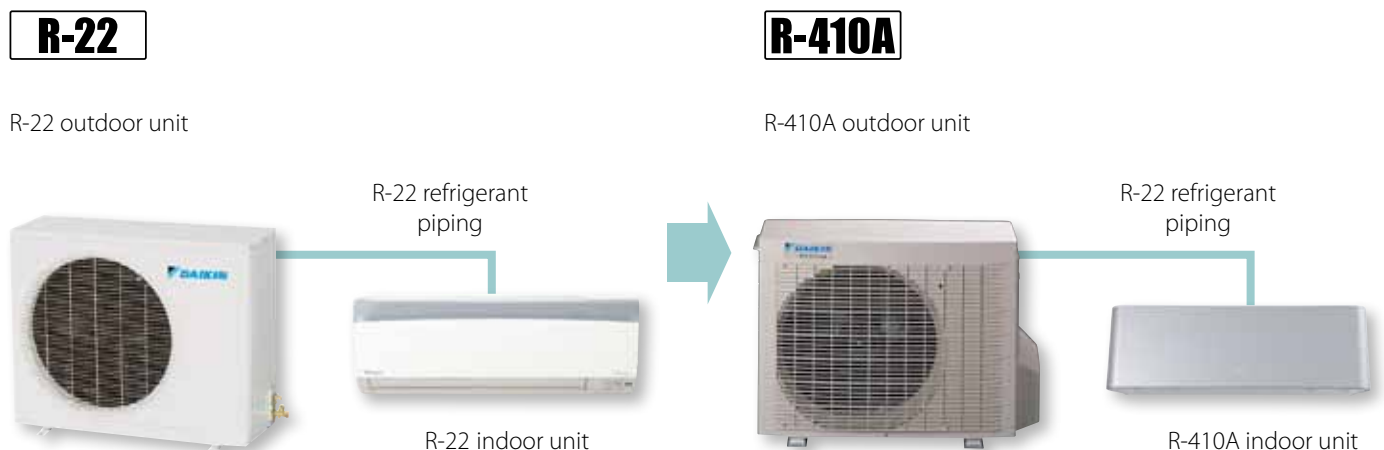

# Benefits of upgrading to an R-410A system

## Fast installation

Since the existing piping can remain, the installation is faster and less intrusive than in the case of a completely new installation. Sometimes, in the case of VRV installations, it is even possible to keep existing indoor units. As a result, the impact on the daily running of the business will be limited.

## Planned downtime

Downtime can be carefully planned: whereas if a problem occurs when not enough reclaimed R-22 is available, a long and unplanned downtime can be the result.

## Reduced installation cost

Keeping the existing pipe work means a faster and less intrusive installation (no need to break open walls) and fewer materials used in the operation, which also translates into economic savings.

## Best design and functionalities

The upgrade into an R-410A system also means accessing a wide choice of innovative indoor units that excel in terms of design, such as the award-winning Daikin Emura, and also in terms of comfort and functionality, such as the round flow cassette.



## Increasing efficiencies

Upgrading an old R-22 system will result in increased system efficiency. Efficiency gains of more than 40% in cooling can be realized, by virtue of technological developments in current heat pump technology and the more efficient R-410A refrigerant. Increased energy efficiency equals lower energy consumption, and subsequently lower energy costs.

Example for VRV

### 35% less consumption in cooling mode

Energy use of a 10HP system in cooling

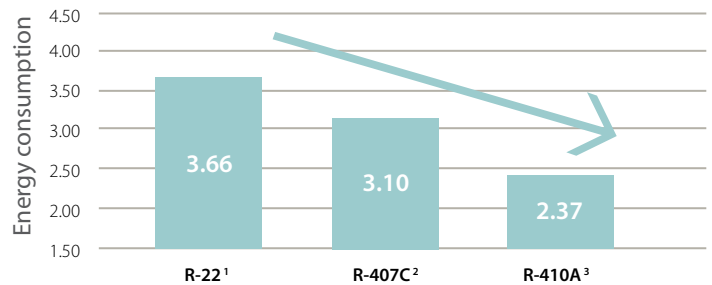

### 18% less consumption in heating mode

Energy use of a 10HP system in heating

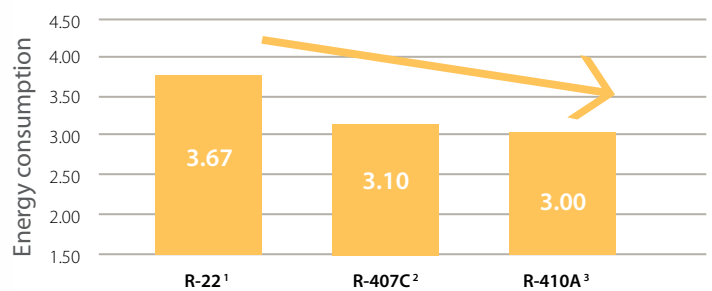

<sup>1</sup> R-22: RSXY-KA7

<sup>2</sup> R-407C: RSXYP-L7

<sup>3</sup> R-410A: RQYQ-P

## Reduced environmental impact

Next to being more energy efficient, and thus producing less CO<sub>2</sub> emissions, R-410A also has zero ozone depletion potential. Furthermore, as no new copper piping is required, less waste is produced during the installation.



reddot design award  
honourable mention 2010



GOOD  
DESIGN



Designpreis  
Deutschland  
2011  
NOMINEE



product  
design  
award  
2010



## R-22, an ozone depleting refrigerant

R-22 is a hydrochlorofluorocarbon (HCFC) which was commonly used in air conditioning systems. When R-22 is released into the air, the ultraviolet rays of the sun cause it to decompose and chlorine is released in the stratosphere. Chlorine reacts with ozone, reducing the amount of the ozone.

Due to ozone layer depletion, harmful ultraviolet rays reach the surface of the earth giving rise to a number of health and environmental issues. The international community therefore, signed the Montreal Protocol to phase out ozone depletion materials by 2030. The European Union however, decided to ban R-22 already in 2015.

Daikin advises to replace your existing installation already today.

## When will R-22 be banned in Europe?

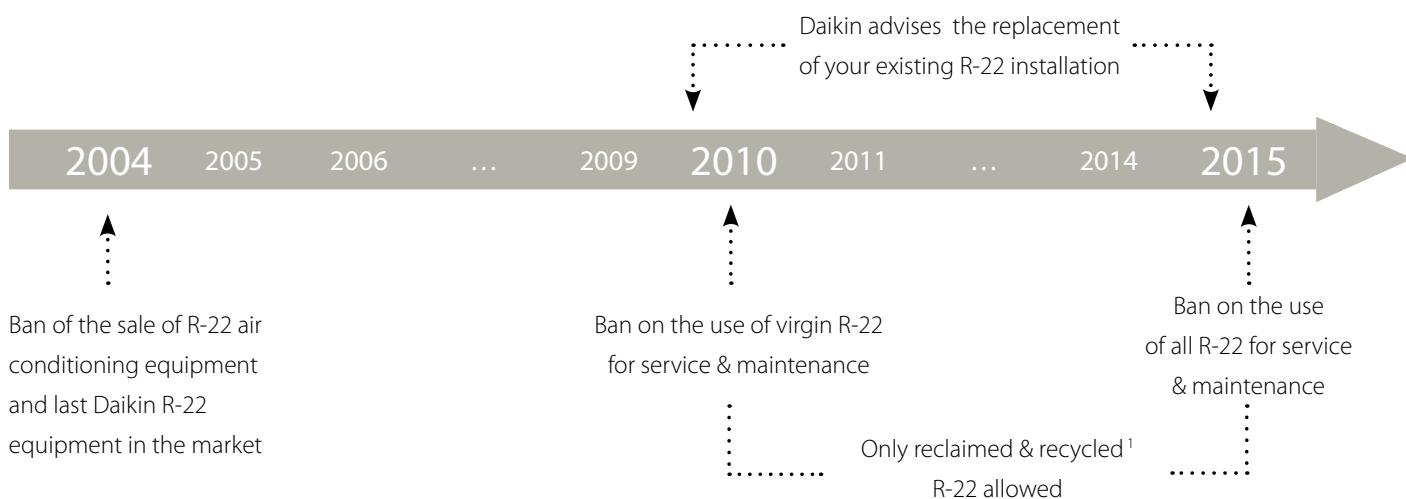

<sup>1</sup> Recycled: re-use of R-22 following a basic cleaning process. Recycled R-22 must be re-used by the same company that carried out the recovery (can be done by installer)  
 Reclaimed: reprocessed R-22 in order to meet the equivalent performance of virgin R-22 (by specialized company)

# Overview of units suitable for replacement - Split and Sky Air

## Pair application

Indoor units			Residential applications - Split							Light commercial applications - Sky Air					
Outdoor units			RXG-K	RXS-K	RXS-F	RX-JV	RX-GV	RXLG-K	RXL-K	RXL-J	RZQG-L8/7V1	RZQG-L(8)Y1	RZQSG-L(3/8)V1	RZQSG-L(8)Y1	RZQ-C
Residential applications - Split	Wall mounted	FTXG-JA/JW	✓					✓							
		FTXS-K		✓					✓						
		FTXS-J								✓					
		FTXS-G			✓										
		FTX-JV				✓									
	FTX-GV					✓									
	Concealed ceiling	FDXS-F		✓	✓				✓	✓					
	Floor standing	FVXG-K	✓						✓						
		FVXS-F		✓					✓	✓					
Flexi type	FLXS-B		✓												
Light commercial - Sky Air	Ceiling mounted cassette	FCQG-F		✓	✓				✓	✓		✓	✓	✓	✓
		FCQH-F									✓	✓	✓	✓	✓
		FFQ-C		✓	✓					✓	✓				
	Concealed ceiling	FBQ-C8		✓	✓					✓	✓		✓	✓	✓
		FDQ-C										✓	✓	✓	✓
		FDQ-B											✓	✓	✓
	Wall mounted	FAQ-C									✓	✓	✓	✓	✓
	Ceiling suspended	FHQ-C		✓	✓					✓	✓		✓	✓	✓
		FUQ-C										✓	✓		
	Floor standing	FVQ-C										✓	✓	✓	✓

Note: The information on the possible connections between indoors and outdoors provided in this leaflet is only an indication. Please always make sure that the specific combination used for replacement is an official combination.

## Multi application

Connectable indoor units	Wall mounted												Floor standing					Flexi type			Round flow cassette			Fully flat cassette			Concealed ceiling					Ceiling suspended																				
	FTXG-JA/JW				FTXS-K				FTXS-G				FTX-JV				FVXG-K					FVXS-F					FLXS-B			FCQG-F			FFQ-C			FDXS-F					FDBQ-B/FBQ-C8					FHQ-C						
	25	35	50	15	35	20	25	35	42	50	60	71	20	25	35	25	35	50	25	35	50	60	35	50	60	25	35	50	60	25	35	50	60	25	35	50	60	25	35	50	60	35	50	60								
2MXS40H	•	•	•	•	•	•	•	•	•			•	•	•				•	•	•													•	•																		
2MXS50H	•	•	•	•	•	•	•	•	•			•	•	•				•	•	•													•	•																		
3MXS40K	•	•	•	•	•	•	•	•	•									•	•	•													•	•																		
3MXS52E	•	•	•	•	•	•	•	•	•									•	•	•													•	•																		
3MXS68G	•	•	•	•	•	•	•	•	•									•	•	•													•	•																		
4MXS68F	•	•	•	•	•	•	•	•	•									•	•	•													•	•																		
4MXS80E	•	•	•	•	•	•	•	•	•									•	•	•													•	•																		
5MXS90E	•	•	•	•	•	•	•	•	•									•	•	•													•	•																		

## Twin /Triple /double application

Capacity class	FCQG-F					FFQ-C		FDXS-F		FBQ-C8					FHQ-C					FUQ-C			FAQ-C			FDQ-C						
	50	60	71	100	125	50	60	50	60	50	60	71	100	125	50	60	71	100	125	71	100	125	71	100	125	71	100	125				
RZQ200C	4	3	3	2		4	3	4	3	4	3	3	2		4	3	3	2					3	2		3	2					
RZQ250C		4			2		4		4		4					2							2						2			

Capacity class	FCQH-F				FCQG-F				FFQ-C				FDXS-F				FBQ-C8				FHQ-C				FAQ-C		FUQ-C						
	71	35	50	60	71	35	50	60	35	50	60	35	50	60	35	50	60	71	35	50	60	71	35	50	60	71	71	71	71				
RZQG71L8V1			2					2						2							2												
RZQG100L8V1			3		2			3	2			3	2	3	2			3	2														
RZQG125L8V1			4	3	2			4	3	2		4	3	2	4	3	2	4	3	2													
RZQG140L7V1	2	4	3					2	4	3		4	3		4	3					2	4	3					2	2				

Capacity class	FCQH-F				FCQG-F				FFQ-C				FDXS-F				FBQ-C8				FHQ-C				FAQ-C					
	71	35	50	60	71	35	50	60	35	50	60	35	50	60	35	50	60	71	35	50	60	71	35	50	60	71	71			
RZQSG71L3V1			2								2										2									
RZQSG100L8V1			3	2					3	2			3	2		3	2					3	2							
RZQSG125L8V1			4	3	2				4	3	2		4	3	2	4	3	2				4	3	2						
RZQSG140LV1			2	4	3				2	4	3		4	3		4	3					2	4	3					2	2

## VRV

HP	5	8	10	12	13	14	16	18	20	22	24	26	28	30	32	34	36	38	40	42	44	46	48	
Capacity class	140		280		360		460	500	540	636	712	744	816	848										
<b>VRVIII-Q</b>																								
RQCEQ-P			✓		✓		✓	✓	✓	✓	✓	✓	✓	✓	✓	✓	✓	✓	✓	✓	✓	✓	✓	✓
VRVIII-Q - H/R																								
HP	5	8	10	12	13	14	16	18	20	22	24	26	28	30	32	34	36	38	40	42	44	46	48	
<b>VRVIII-Q</b>																								
RQYQ-P	✓	✓	✓	✓			✓	✓	✓	✓	✓	✓	✓	✓	✓	✓	✓	✓	✓	✓	✓	✓	✓	
VRVIII-Q - H/P																								

# Procedure for Split/Sky Air

## Re-use of the existing pipe work

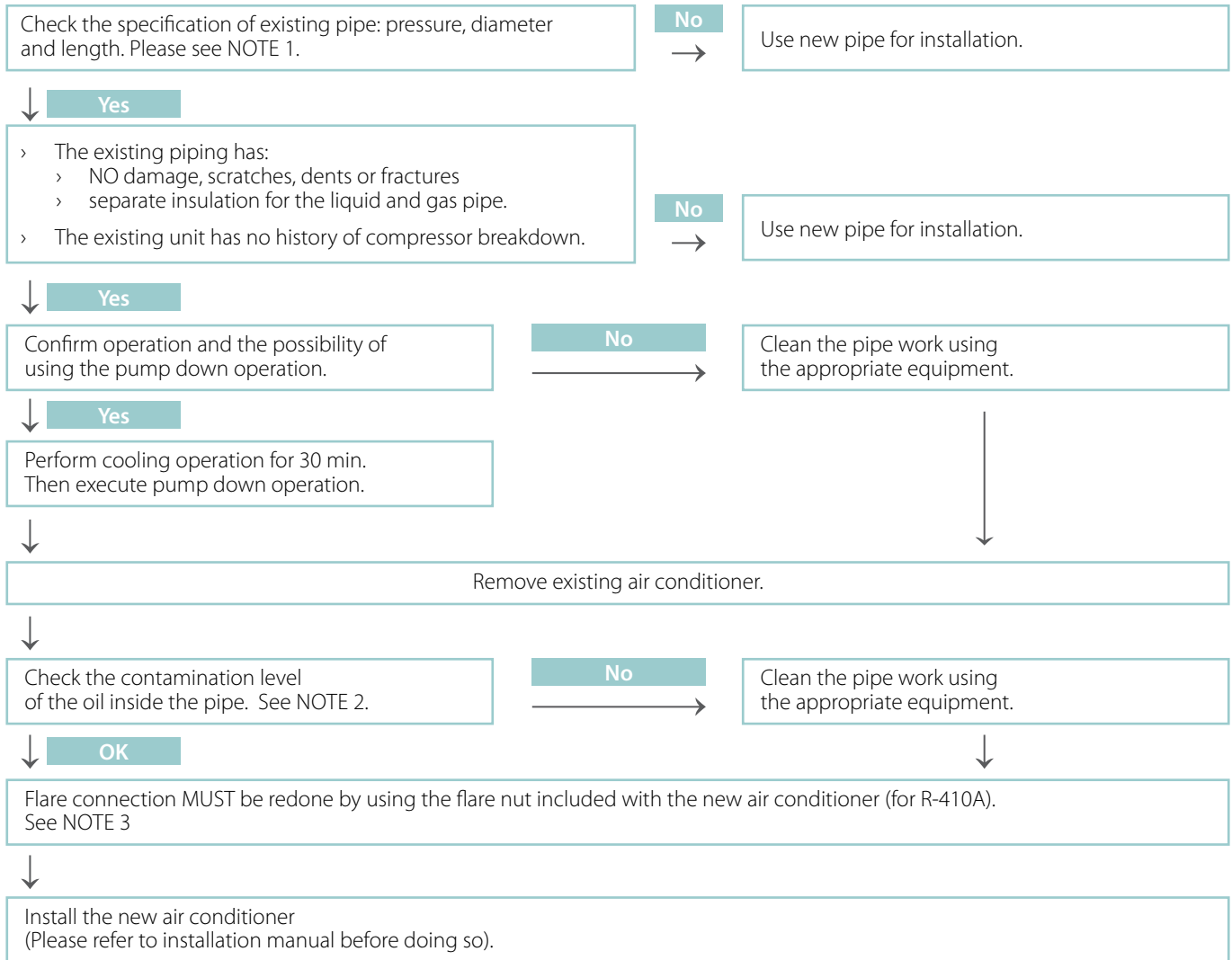

## Re-use of the existing wiring

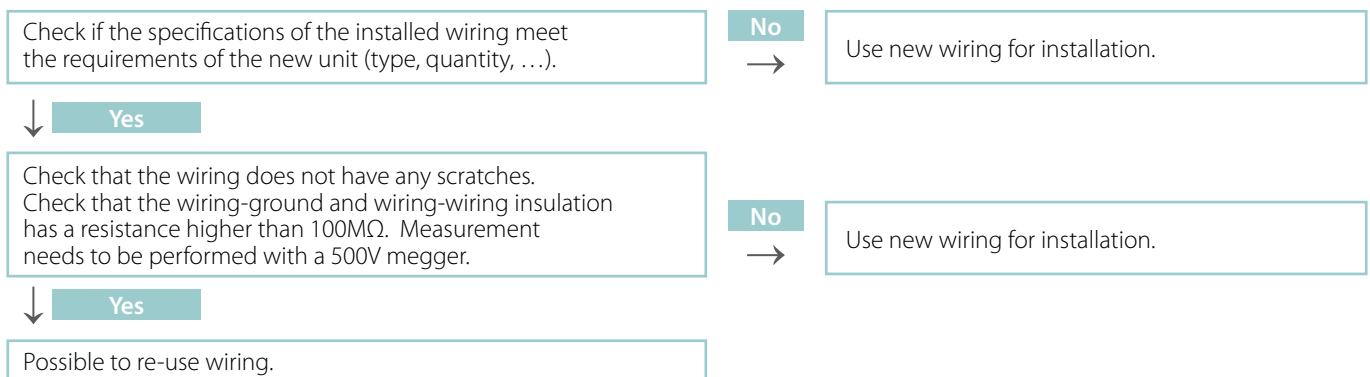

## NOTE 1/ Pipe specifications

### 1. Pipe thickness

Outside diameter (mm)	Material	Thickness (mm)
6.4	O	0.8
9.5	O	0.8
12.7	O	0.8
15.9	O	1.0
19.1	1/2H	1.0

O: annealed  
1/2H: half hard

### 2. Capacity class and pipe diameter

	Liquid Gas	6.4			9.5		12.7	
		9.5	12.7	15.9	19.1	15.9	19.1	
Split	2.0-4.2kW	•	o	x	x	x	x	x
	5.0-6.0kW	x	•	o	x	x	x	x
	7.1kW	x	x	•	Δ	x	x	x
Sky Air	7.1kW	x	Δ	Δ	•	x	Δ	x
	10.0-14.0kW	x	x	Δ	•	o	Δ	Δ

- Possible (Standard condition)
- o Possible (With no impact on chargeless length\* and total length)
- Δ Possible (With impact on chargeless length\* and total length)
- x Impossible

refer to NOTE 1.3 for more information

### 3. Chargeless length\* and total length

Split	Liquid pipe	7.1kW
Chargeless length	6.4mm	10m
	9.5mm	4m
Max. total length	6.4mm	30m
	9.5mm	12m

If the installation requires longer piping length than chargeless length, add refrigerant at the rate of 20g/m (liquid pipe: 6.4mm), 50g/m (liquid pipe: 9.5mm)

Sky Air (RZQG)	Liquid pipe	71	100	125-140
Chargeless (equivalent)	6.4mm	10m (15m)		
	9.5mm	30m (40m)		
	12.7mm	15m (20m)		
Max. total length (equivalent)	6.4mm	10m (15m)		
	9.5mm	50m(70m)	75m (95m)	
	12.7mm	25m(35m)	35m(45m)	

Sky Air (RZQSG)	Liquid pipe	71	100	125-140
Chargeless (equivalent)	6.4mm	10m (15m)		
	9.5mm	25m (35m)		
	12.7mm	10m (15m)		
Max. total length (equivalent)	6.4mm	10m (15m)		
	9.5mm	30m (50m)	50m (70m)	
	12.7mm	15m (25m)	25m (35m)	

Follow the installation manual for additional refrigerant charge.

\* Maximum piping length achievable without additional refrigerant charge.

Multi model application	Liquid pipe	Chargeless length	Max. Total length
2MXS40	6.4mm	20m	30m
2MXS50			
3MXS52		30m	50m
3MXS68			
4MXS68			
4MXS80			
5MXS90		75m	

If the installation requires longer piping length than chargeless length, add refrigerant at the rate of 20g/m (Liquid pipe: 6.4mm). Should any 9.5 mm piping be in place, use the following formula to determine the required additional refrigerant charge.

ARC=Yx50+(X-30)x20  
 ARC: additional refrigerant charge (g)  
 X: 6.4mm liquid piping length (m)  
 Y: 9.5mm liquid piping length (m)

In case of 4MX80: If 0 < ARC < 800 g, apply ARC  
 If ARC > 800 g, apply 800 g (MAX)  
 If ARC < 0 g, no additional refrigerant charge required

In case of 5MX90: If 0 < ARC < 900 g, apply ARC  
 If ARC > 900 g, apply 900 g (MAX)  
 If ARC < 0 g, no additional refrigerant charge required

## NOTE 2/ Contamination level of the oil

Check the colour of the oil in the existing piping by dipping a piece of white paper or cloth into it. If the oil is colourless, the re-use of the pipe work in place is allowed. An oil checking card can also be used for this purpose (reference nr = 4PW18628-1).

## NOTE 3/ Flare connection

Precautions for flare connection:

- > Please refer to the table for the dimensions for processing flares and for the tightening torques. (Too much tightening will end up splitting of the flare.)
- > When connecting the flare nut, apply refrigerating machine oil to the flare (inside and outside) and first screw the nut 3 or 4 turns by hand.
- > After completing the installation, carry out a gas leak inspection of the piping connections with nitrogen and such.

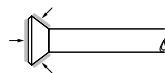

Piping size	Flare nut tightening torque	All dimensions for processing flares (mm)	flare shape
Ø6.4	14.2~17.2 N·m (144~176 kgf·cm)	8.7~9.1	
Ø9.5	32.7~39.9 N·m (333~407 kgf·cm)	12.8~13.2	
Ø12.7	49.5~60.3 N·m (504~616 kgf·cm)	16.2~16.6	
Ø15.9	61.8~75.4 N·m (630~770 kgf·cm)	19.3~19.7	
Ø19.1	97.2~118.6 N·m (989.8~1208 kgf·cm)	23.6~24.0	

## NOTE 4/ Sky Air installation:

In case of twin, triple and double twin installations, a strength pressure test must be performed on the existing piping and piping joints. This test needs to be executed according to EN 378-2 (2009), chapter 6.3.3. The acceptance criteria for the test is that no permanent deformation shall occur in the piping and piping joints at a test pressure of minimum 1.1xPS (PS = maximum allowable pressure). Only in that case is the re-use of the piping and piping joints possible (please check the nameplate of the replacement unit to determine the maximum allowable pressure PS). The strength pressure test should be followed by a tightness test, according to EN 378-2 (2009), chapter 6.3.4.

## NOTE 5/ Precautions for refrigerant piping

- > Foreign material (air, mineral oil, moisture, ...) should be prevented from getting mixed into the system. If any refrigerant gas leaks while working on the unit, ventilate the room thoroughly right away.
- > Only use R-410A as a refrigerant.  
 Installation tools: use only installation tools (gauge manifold charge hose, etc.) that are appropriate for R-410A installations so as to withstand the pressure.  
 Vacuum pump: use a 2-stage vacuum pump with a non-return valve. Make sure the pump oil does not flow back into the system while the pump is not working. Use a vacuum pump which can evacuate to -100.7 kPa (5 Torr. -755 mmHg).
- > If the local piping has welded connections, check them for gas leaks.

# Procedure for VRV

## What should be replaced?

1. Replace outdoor unit.
2. Replace BS-boxes (in case of H/R)
3. Replace indoor units if required <sup>1</sup>
4. The system will automatically clean the piping & charge the correct amount of R-410A refrigerant

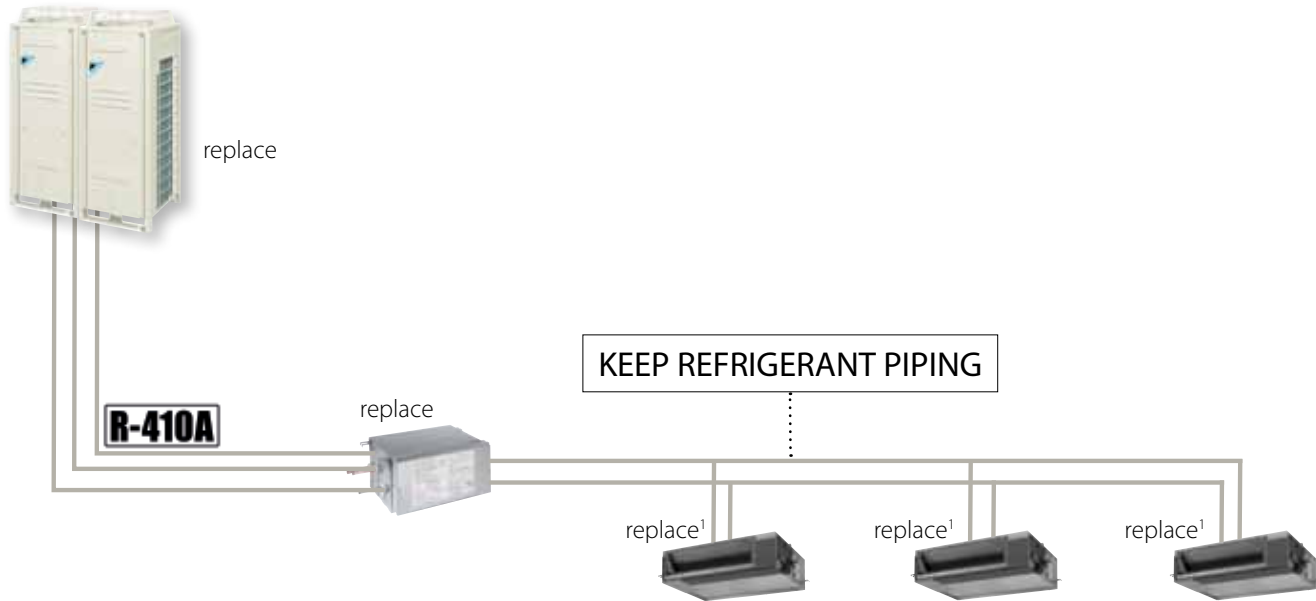

<sup>1</sup> Indoor units from K-series or later can remain. Mix of old R-22 and new R-410A indoor units is not possible.

## Additional precautions when replacing a non-Daikin system

Check if the installed refrigerant piping can be re-used. Check wall thickness, diameter, refrigerant branch pipes, piping lengths, refrigerant oil and insulation according to the following minimum requirements.

### Minimum wall thickness

The existing piping should have a design pressure of 3.3 MPa. There should be no corrosion. Minimum wall thickness should follow the table below:

Nominal diameter of pipe	O material		1/2H, H material	
	Min. wall thickness	Daikin indication for R-22 VRV	Min. wall thickness	Daikin indication for R-22 VRV
Ø 6.4	0.4	0.8	-	-
Ø 9.5	0.5	0.8	(0.3)	-
Ø 12.7	0.7	0.9	(0.4)	-
Ø 15.9	0.9	1.0	(0.5)	-
Ø 19.1	1.0	1.0	(0.6)	-
Ø 22.2	1.15	1.2	0.6	1.0
Ø 25.4	(1.4)	-	0.7	1.2
Ø 28.6	(1.5)	-	0.8	1.2
Ø 31.8	(1.7)	-	0.9	1.4
Ø 38.1	(2.0)	-	1.1	1.4
Ø 44.5	(2.4)	-	1.2	1.6



## Refrigerant branch pipes

Refrigerant branch pipes can be re-used if they can withstand a pressure of 3.3 MPa. The Y-refnets, T-refnets and headers can be re-used. Special items that implement decompression (for example: an oil trap) are not allowed.

## Maximum piping lengths

Check if piping lengths are within the parameters.

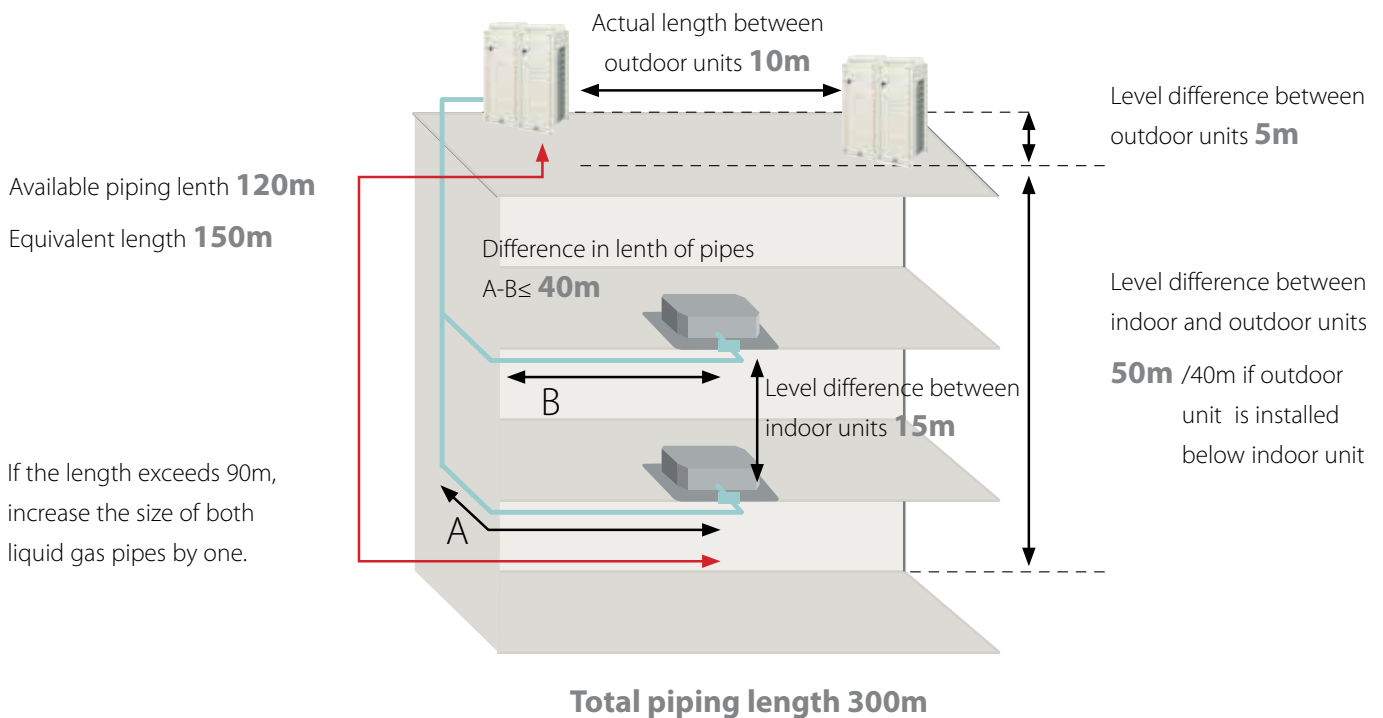

## Piping diameters

Check if existing piping diameters are acceptable for the required capacity. Please contact your local dealer for more information.

## Insulation of refrigerant piping

Both gas and liquid piping should be insulated.

## Refrigerant oil

If one of the following oils was used the refrigerant piping can be re-used:

- > Suniso
- > MS
- > HAB
- > Barrel Freeze
- > Ferreol
- > Ethereal
- > Ester



## VRV III-Q features

### Fast installation

It is not necessary to remove the existing piping and even the indoor units can remain (depending on type of indoor unit). This means work only has to be carried out at the outdoor unit and not inside your building in case of a heat pump installation. The outdoor unit automatically charges the refrigerant and cleans the refrigerant piping. This unique Daikin feature makes the installation time even shorter.

### No limitations on system history

As a result of the combined automatic charging and refrigerant pipe cleaning function, it is possible to ensure a clean piping network, even when a compressor breakdown has previously occurred. In this way all correctly installed R-22 and R-407C VRV and competitor VRF systems can be replaced.

### Limited and phased investment cost

It is possible to spread the various stages of replacement over a period of time because the indoor units can remain in most cases. The air conditioning replacement could, therefore, be incorporated in the general refurbishment schedule of the building and the investment cost can be spread. A further reduction in installation cost can be achieved by maintaining the existing refrigerant copper pipe work.

### Possibility of increasing the capacity

Cooling loads often increase after to the initial installation of the air conditioning system. The Replacement VRV (VRV III-Q) enables system capacity to be increased without changing the refrigerant piping (depending on system characteristics). For example: it is possible to install a 16 HP Replacement VRV on the refrigerant piping of an R-22 10 HP system.

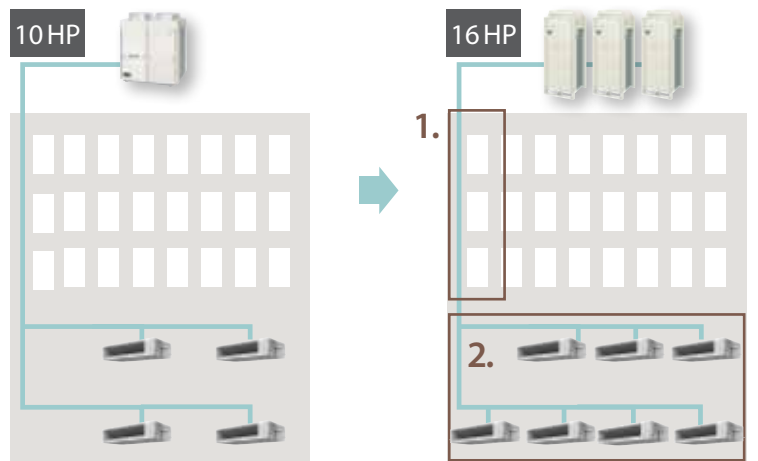

1. Keep main piping
2. Install indoor units with a higher total capacity

# Technologies of VRVIII-Q

## Reduced pressure

Older R22 VRV systems work on a lower pressure than today's R-410A systems. However thanks to the sub cool circuit, VRV-Q is capable of operating at lower pressures than the standard VRV series, while still maintaining high efficiency levels.

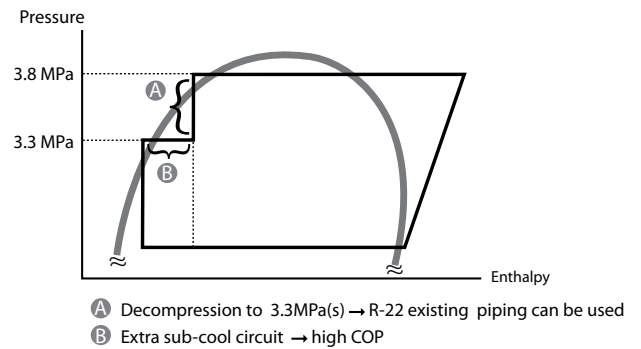

## Refrigerant pipe cleaning

When replacing an air conditioning system, the piping is normally replaced as well since traces of old refrigerant and oil mixed with the oil and refrigerant of the new system can cause the equipment to malfunction.

In order to allow re-use of existing R-22 piping with an R-410A system, Daikin have developed a technology to capture and retain the contamination left in the refrigerant piping. During the charging of the system, R-410A refrigerant starts circulating through the

copper piping collecting the contamination left in the system. The refrigerant, including the remaining oil from the R-22 system, is filtered in the outdoor unit and the contamination is deposited there. This process is executed only once and takes maximum 1 hour. Daikin is the first manufacturer in the industry to develop this combination of automatic charging and a refrigerant pipe cleaning function.

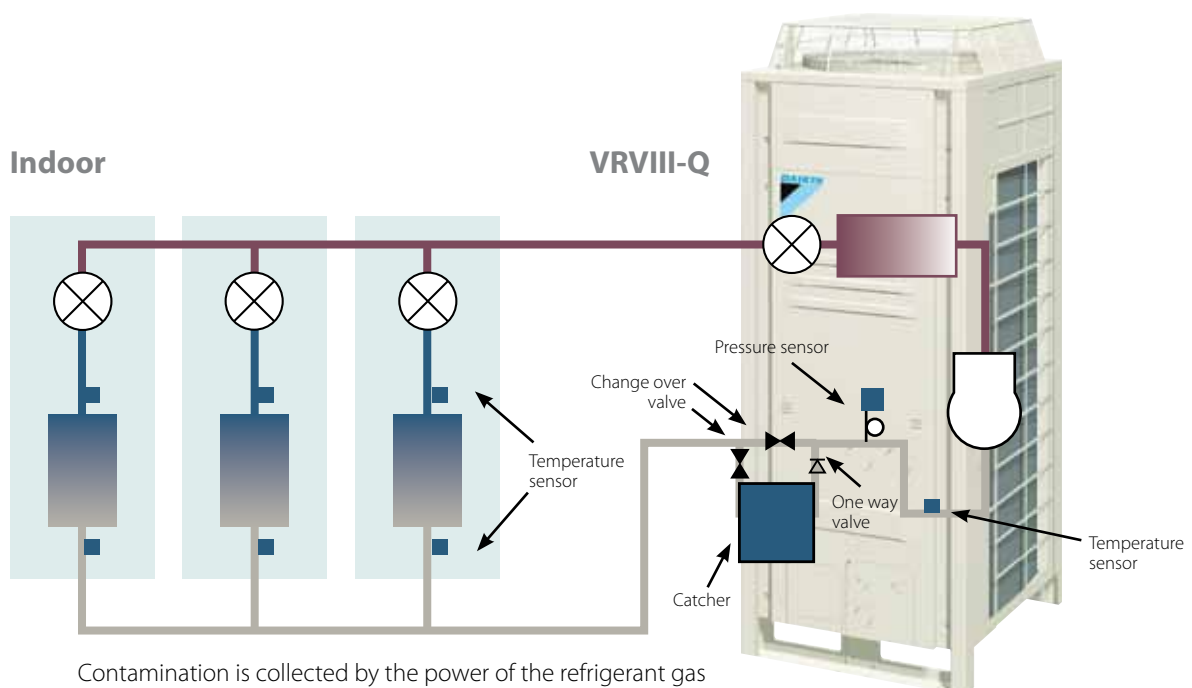



Daikin's unique position as a manufacturer of air conditioning equipment, compressors and refrigerants has led to its close involvement in environmental issues. For several years Daikin has had the intention to become a leader in the provision of products that have limited impact on the environment. This challenge demands the eco design and development of a wide range of products and an energy management system, resulting in energy conservation and a reduction of waste.

The present leaflet is drawn up by way of information only and does not constitute an offer binding upon Daikin Europe N.V. Daikin Europe N.V. has compiled the content of this leaflet to the best of its knowledge. No express or implied warranty is given for the completeness, accuracy, reliability or fitness for particular purpose of its content and the products and services presented therein. Specifications are subject to change without prior notice. Daikin Europe N.V. explicitly rejects any liability for any direct or indirect damage, in the broadest sense, arising from or related to the use and/or interpretation of this leaflet. All content is copyrighted by Daikin Europe N.V.



Daikin Europe N.V. participates in the Eurovent Certification programme for Air conditioners (AC), Liquid Chilling Packages (LCP) and Fan coil units (FCU). Check ongoing validity of certificate online: [www.eurovent-certification.com](http://www.eurovent-certification.com) or using: [www.certiflash.com](http://www.certiflash.com)

VRV products are not within the scope of the Eurovent certification programme.

FSC

ECPEN13-115

Daikin products are distributed by: